



MACCHINE

AGRICOLE

REMAC



TRINCIATRICI

RTSI-RTE-RTF-RTG-RTGP

20 ÷ 160 HP



TRINCIATRICI RTSI-RTE-RTF-RTG-RTGP

20 ÷ 160 HP



FLOATING SYSTEM

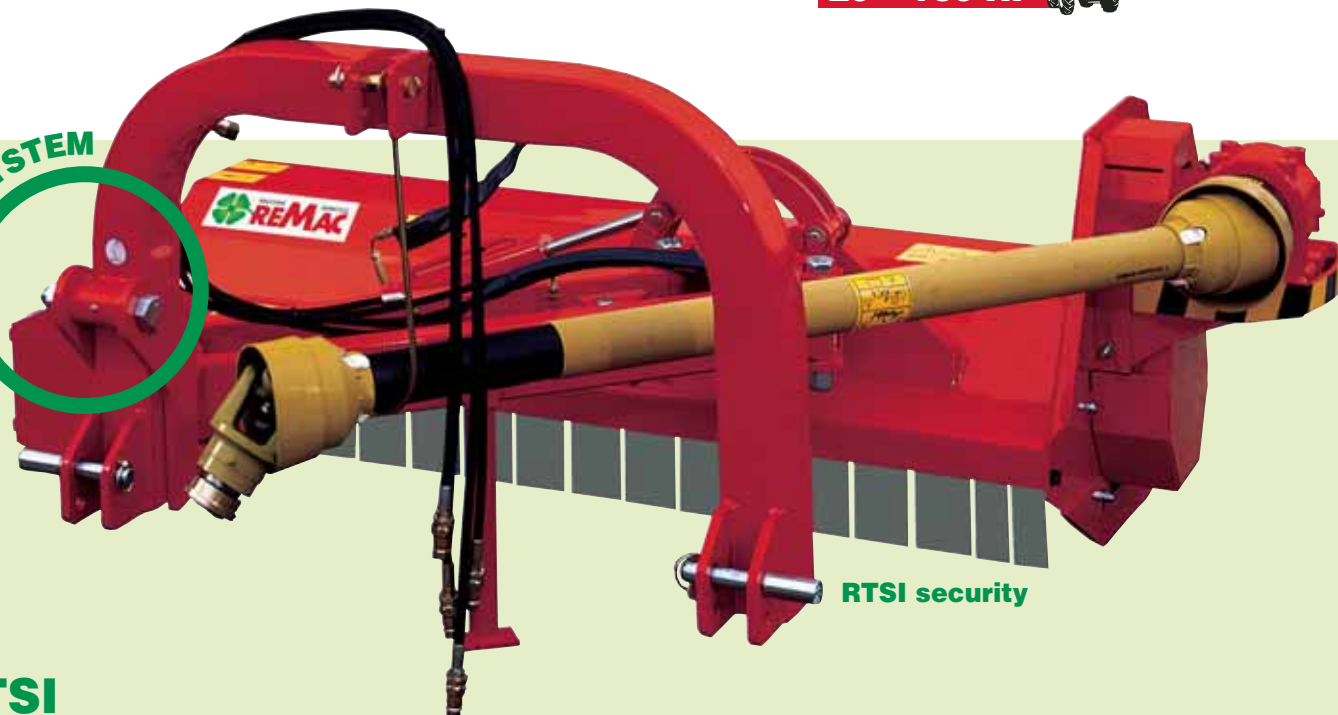

RTSI security

RTSI

Trinciatrice spostabile inclinabile per manutenzione aree verdi, agricoltura, speciale per bordi stradali, argini, parchi e giardini.

- Inclinazione idraulica 90°↑ - 70°↓
- Spostamento laterale idraulico a parallelogramma
- Snodo per autolivellamento (Floating System)
- Potenza richiesta da 40 a 80 HP.

Movable, inclinable shredder for farming, maintaining green areas, specially suitable for road edges, embankments, parks and gardens.

- Hydraulic inclination 90°↑ - 70°↓
- Side parallelogram displacement
- Self-levelling floating system
- Required power: 40 - 80 hp

Broyeur mobile, inclinable pour l'entretien des espaces verts et pour l'agriculture. Idéal pour le bord de route, les digues, les parcs et les jardins.

- Inclinaison hydraulique : 90°↑ 70°↓.
- Déplacement latéral hydraulique et parallélogramme
- Rotule de système flotteur
- Puissance nécessaire 40 à 80 HP.

Versetzbare und schrägverstellbare Schneidemaschinen für die Wartung von Grünflächen, Landwirtschaft, speziell für Strassenränder, Deiche, Parks und Gärten.

- hydraulische Neigung von 90°↑ - 70°↓
- hydraulische Parallelogramm-Seitenverschiebung
- Gelenk für Selbstebnung (Floating system)
- Erforderliche Leistung von 40 bis zu 80 PS.

RTF

Trinciatrice per erba, legna, set-aside e manutenzione aree verdi. Potenza richiesta da 40 a 120 HP.

Shredder for grass, wood, set-aside and maintenance of green areas. Required power: 40 - 120 HP.

Broyeur pour l'herbe, le bois, le set-aside et l'entretien des espaces verts. Puissance nécessaire 40 à 120 HP.

Schneidemaschinen für Grün, Brennholz, Set-aside und Wartung von Grünflächen. Erforderliche Leistung von 40 bis zu 120 PS.



RTE

Trinciatrice per sarmenti, erba e manutenzione aree verdi. Potenza richiesta da 20 a 60 HP.

Shredder for sarments, grass and maintenance of green areas. Required power: 20 - 60 HP.

Broyeur pour les sarments, l'herbe et l'entretien des espaces verts. Puissance nécessaire 20 à 60 HP.

Schneidemaschine für Ranken, Grün und Wartung von Grünflächen. Erforderliche Leistung von 20 bis zu 60 PS.



 Gamma completa di trinciatrici robuste ed affidabili, in grado di soddisfare le più svariate richieste. Il telaio rinforzato, la trasmissione sovradimensionata, i rotori ottimamente equilibrati, gli utensili di taglio costruiti con materiali di primaria qualità ed il basso assorbimento di potenza, assicurano lavorazioni veloci ed accurate sia nella manutenzione del verde che in agricoltura.

 A complete range of robust and reliable shredders meeting all requests. The strengthened frame, the oversize drive, the perfectly calibrated rotors, the cutting tools that are made up of first-grade materials and the low power absorption, these are all features assuring quick and careful operations in farming as well as in maintaining green areas.

 Gamme complète de broyeur solides et fiables, capables de satisfaire de différents besoins. Le châssis renforcé, la transmission surclassée, les rotors parfaitement équilibrés, les outils de coupe fabriqués à partir de matières de toute première qualité et la faible absorption de puissance assurent un travail rapide et soigné tant en ce qui concerne l'entretien des espaces verts que dans le domaine de l'agriculture.

 Komplette Serie von stabilen und zuverlässigen Schneidemaschinen für die unterschiedlichsten Erfordernisse. Der verstärkte Rahmen, das überdimensionierte Getriebe, die optimal ausgeglichenen Rotoren, die aus qualitativ hochwertigen Materialien hergestellten Schneidwerkzeuge und der geringe Leistungsbedarf gewährleisten ein schnelles und sorgfältiges Arbeiten sowohl bei der Wartung der Grünflächen wie in der Landwirtschaft.

RTSI

Versione SECURITY con maggiore spostamento laterale (+ 45 cm). Esempio su trattore da 2 m. Spazio di sicurezza cm 45.

SECURITY version. Example on a 2m-long tractor; safety space cm 45.

Version SECURITY. Exemple sur tracteur de 2 m., espace de sécurité, cm 45.

SECURITY Ausführung. Beispiel auf Zugmaschine von 2 m; Sicherheitsabstand 45 cm.

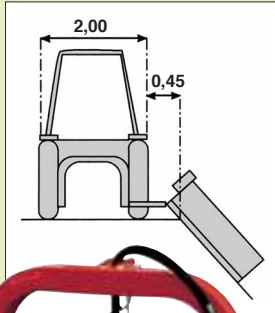

RTGI

RTG

Trinciatrice per paglia, stocchi di mais, sarmenti, erba e soia. Potenza richiesta da 50 a 160 HP.

Shredder for straw, maize stalks, sarments, grass and soya. Required power: 50 ÷ 160 HP.

Broyeur pour la paille, les quenouilles de maïs, les sarments, l'herbe et le soja.

Puissance nécessaire 50 à 160 HP.

Schneidemaschine für Stroh, Mais, Ranken, Grün und Soja. Erforderliche Leistung von 50 bis zu 160 PS.

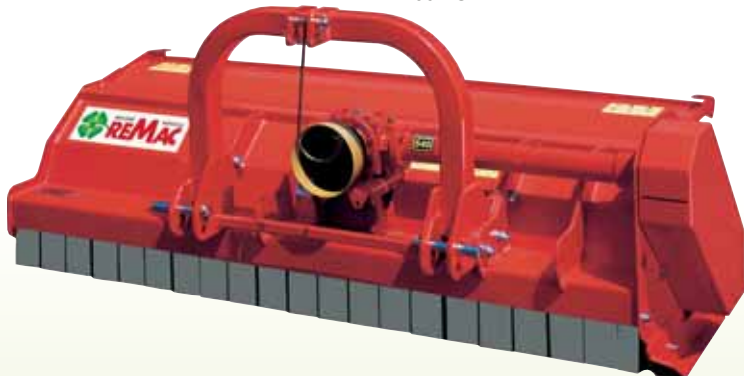

RTGP

Trinciatrice ripieghevole per grandi estensioni. Potenza richiesta da 120 a 160 HP. Telaio pieghevole idraulico per trasporto stradale.

Foldable shredder for large expanses. Required power: 120 ÷ 160 HP. Foldable, hydraulic frame for road transportation.

Royeur pliant pour grands espaces. Puissance nécessaire 120 à 160 HP. Châssis pliant, système hydraulique, pour transport routier.

Zusammenklappbare Schneidemaschine für grosse Flächen. Erforderliche Leistung von 120 bis zu 160 PS. Zusammenklappbarer Hydraulikrahmen für Straßentransport

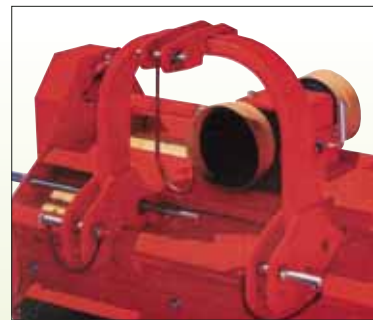









Versione reversibile con attacco frontale e posteriore (mod. RTE e RTF).

Reversible version with front and rear connection (mod. RTE and RTF).

Version réversible avec attelage frontal et arrière. (mod. RTE et RTF)

Reversible Ausführung mit vorderem und hinterem Anschluß (mod. RTE und RTF).



		Larghezza lavoro Working width Largeur de travail Arbeitsbreite	Larghezza Width Largeur Abmessung	Potenza richiesta Required power Puissance demandée Erforderliche Leistung	Peso Weight Poids Gewicht	Velocità P.D.F. P.T.O. rpm P.d.F. T/min Zapfwelle U.P.M.	Rotori - Rotors - Rotors - Rotoren Type B Type E/1 Type C Type D			
		cm	cm	HP	Kg	giri/min.	 n°.	 n°.	 n°.	 n°.
RTE 20 ÷ 60 HP 	RTE 105	930	1070	20 - 30	220	540	28	-	14	-
	RTE 125	1130	1270	30 - 40	240	540	32	-	16	-
	RTE 145	1330	1470	40 - 50	260	540	40	-	20	-
	RTE 165	1530	1670	50 - 60	280	540	44	-	22	-
RTSI 40 ÷ 80 HP 	RTSI 130	1250	1455	40 - 50	480	540	48	-	24	-
	RTSI 165	1540	1745	50 - 60	550	540	64	-	32	-
	RTSI 185	1800	2005	60 - 70	590	540	80	-	40	-
	RTSI 200	1960	2185	70 - 80	630	540	80	-	40	-
RTF 40 ÷ 120 HP 	RTF 165	1540	1745	40 - 50	420	540	64	-	32	-
	RTF 185	1800	2005	50 - 60	450	540	80	-	40	-
	RTF 200	1960	2165	60 - 80	490	540	80	-	40	-
	RTF 225	2145	2372	80 - 90	665	540	-	48	-	24
	RTF 250	2400	2667	90 - 100	736	540	-	52	-	26
	RTF 280	2470	2967	100 - 110	810	540	-	60	-	30
	RTF 300	2930	3157	110 - 120	850	540	-	68	-	34
RTG 50 ÷ 160 HP 	RTG 185	1730	1957	50 - 60	576	540	-	40	-	20
	RTG 200	1938	2165	60 - 70	618	540	-	44	-	22
	RTG 225	2145	2372	70 - 80	660	540	-	48	-	24
	RTG 250	2400	2667	80 - 90	730	540	-	52	-	26
	RTG 280	2740	2967	90 - 100	800	540	-	60	-	30
	RTG 300	2930	3157	100 - 110	842	540	-	68	-	34
	RTG 325	3150	3580	110 - 120	1190	1000	-	96	-	-
	RTG 325/S	3150	3580	110 - 120	1330	1000	-	96	-	-
	RTG 400	3950	4390	120 - 140	1510	1000	-	96	-	-
	RTG 500	4910	5330	140 - 160	1730	1000	-	160	-	-
RTGP 120 ÷ 160 HP 	RTGP 440	4420	4880	120 - 140	1870	1000	-	144	-	-
	RTGP 500	4910	5340	140 - 160	2080	1000	-	160	-	-

RTSI	A - B	C	D	E	F
RTSI 130	↑ 90° - 70° ↓	m. 1,50	m. 1,75	m. 1,10	m. 1,90
RTSI 165	↑ 90° - 70° ↓	m. 1,50	m. 1,75	m. 1,10	m. 2,15
RTSI 185	↑ 90° - 70° ↓	m. 1,50	m. 1,75	m. 1,10	m. 2,35
RTSI 200	↑ 90° - 70° ↓	m. 1,50	m. 1,75	m. 1,10	m. 2,50

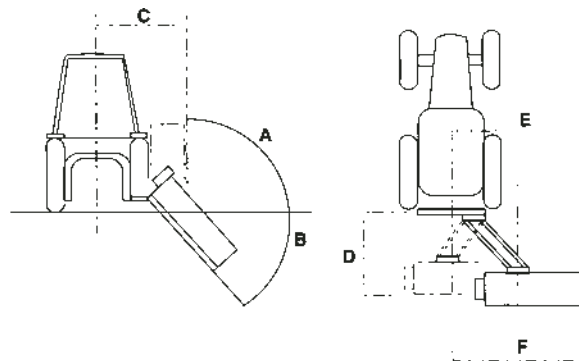

Dati descrizioni e illustrazioni sono forniti a titolo indicativo e non impegnativo.
 Data, description and illustrations are for information purpose only, and are not binding.
 Données, descriptions et illustrations sont fournies à titre indicatif et sans engagement.
 Daten, Beschreibungen und Abbildungen sind hinweisend und nicht verbindlich.



GRAZIOLI REMAC s.r.l.

Via Carpenedolo, 24/A Loc. Mezzane - 25012 Calvisano (BS) Italy

Tel. +39-030.99.66.019 - 96.98.860 - Fax: +39-030.99.66.381

E-mail: info@grazioliremac.it - www.grazioliremac.it

